

Solutions to Common Distribution Protection Challenges

Jeremy Blair, Greg Hataway, and Trevor Mattson
Schweitzer Engineering Laboratories, Inc.

Common Distribution Protection Problems

- Unnecessary operations on fast curve due to inrush
- Long protection times as multiple devices coordinate
- Operation of feeder relay caused by conductor slap
- Closure into faults in loop schemes from lack of communication

Distribution System Protection Challenges

- Zones of protection are large and diverse
- Selectivity is classically established using time
- Topology is dynamic
- Maximum load conditions can be close to minimum fault conditions

Distribution System Protection

Advantages

- Multiple shots of reclosing
- Measurements distributed across the protected system
- Advanced feeder relays and recloser controls
 - Event records
 - Historical data
 - Multiple protection elements
 - Custom logic

Eliminate Unnecessary Fast-Curve Operations Problem

- High speed
- High sensitivity
- Low security during inrush
 - Magnetizing inrush
 - Load inrush
- Frequent exposure to inrush due to reclosing

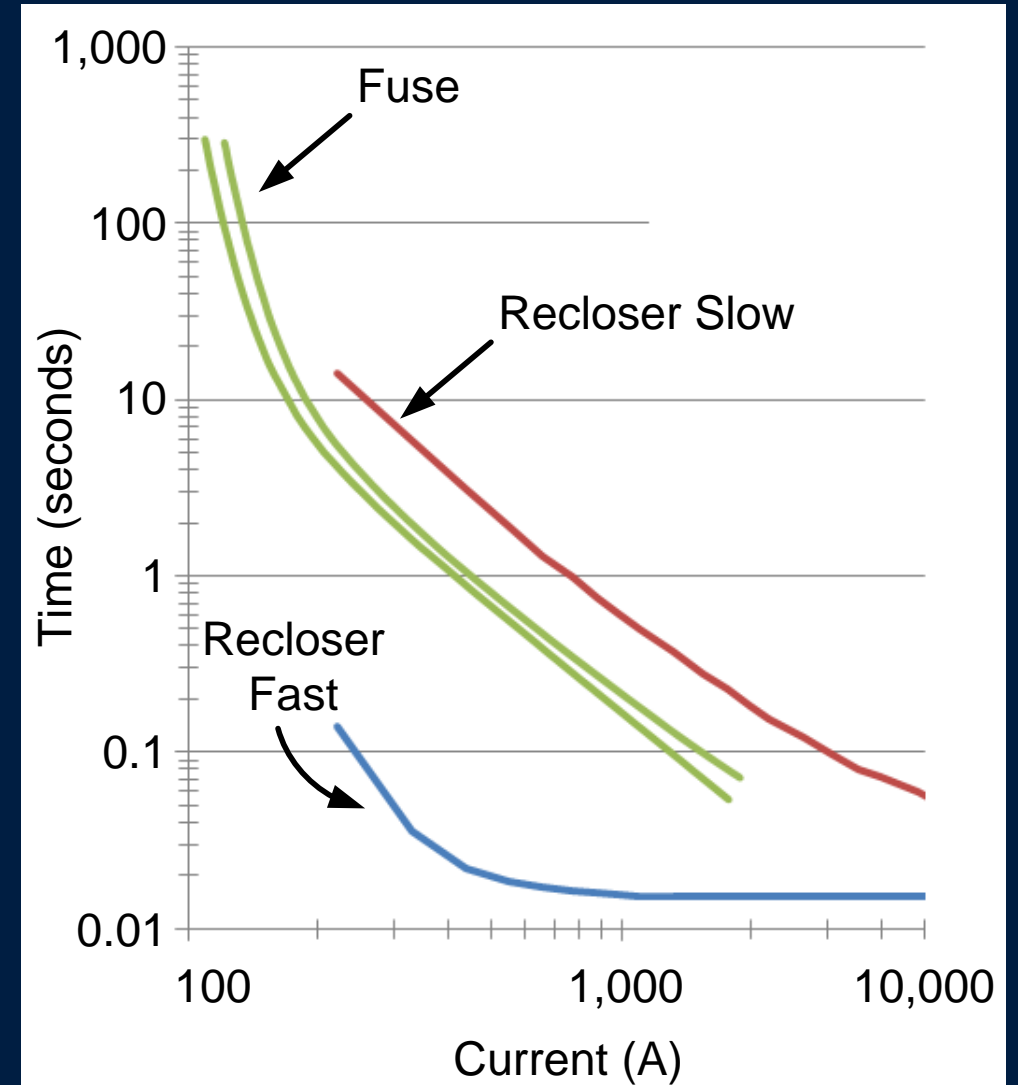

Eliminate Unnecessary Fast-Curve Operations

Example – R2 Trips on Inrush When R1 Recloses

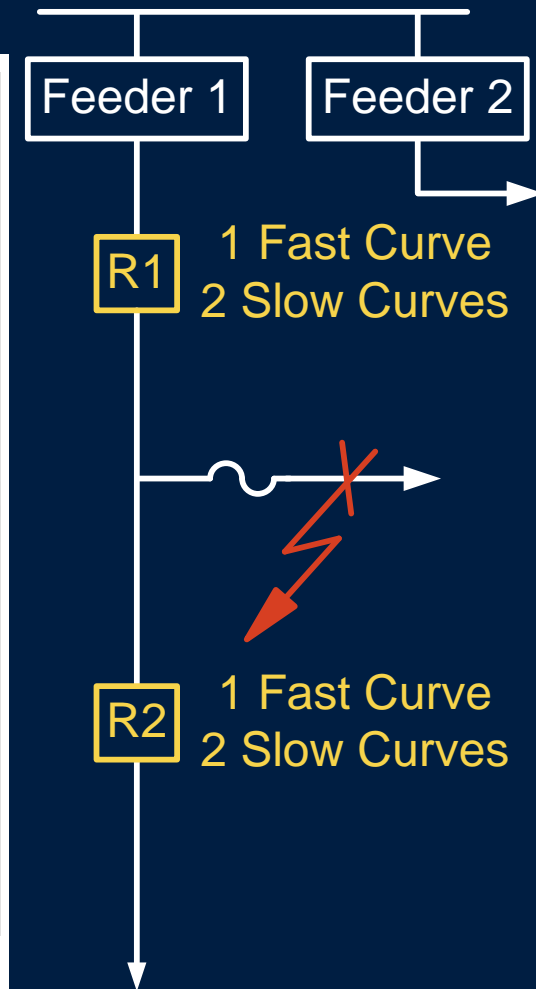
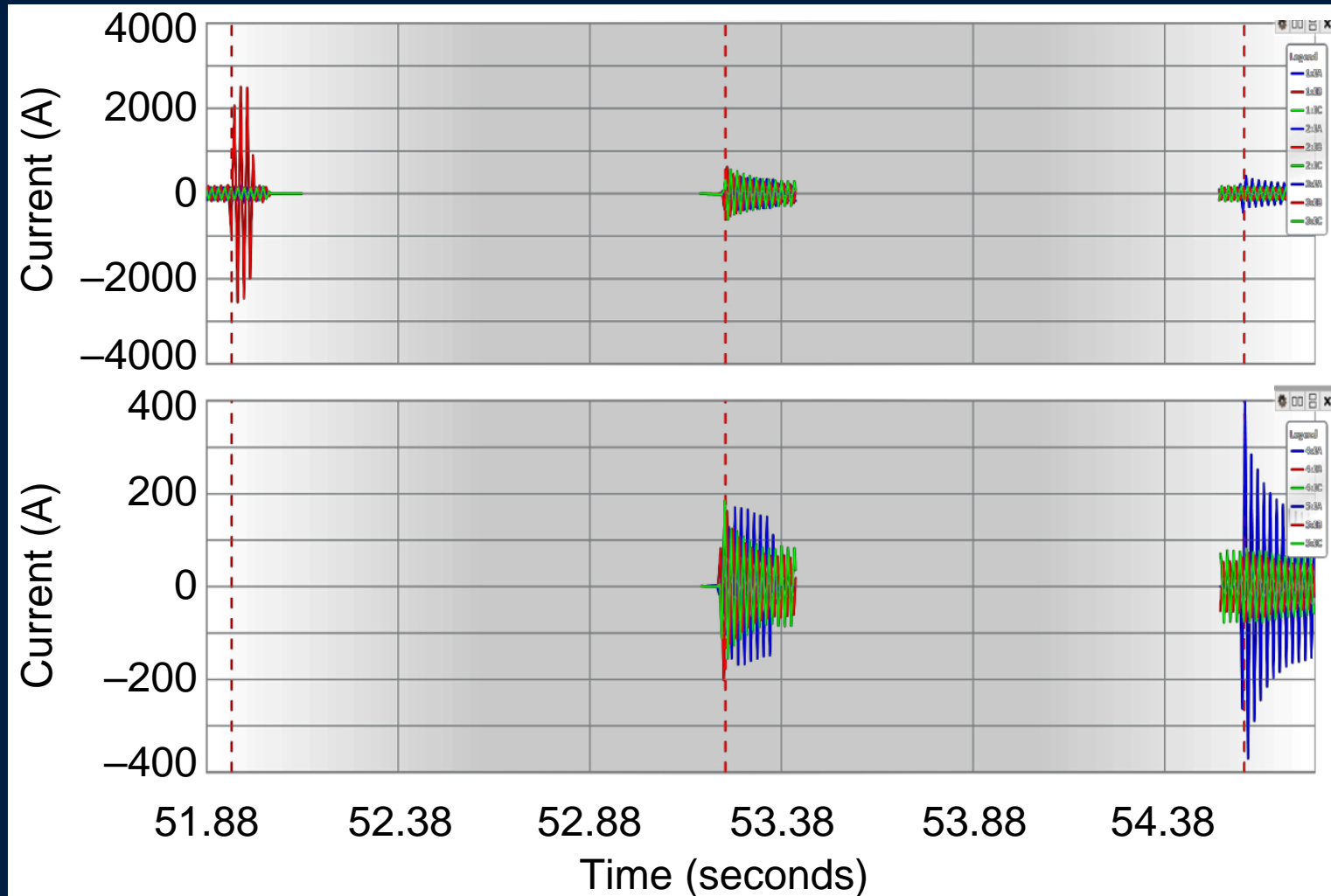

Eliminate Unnecessary Fast-Curve Operations

Solution 1 – Use Slower Fast Curve

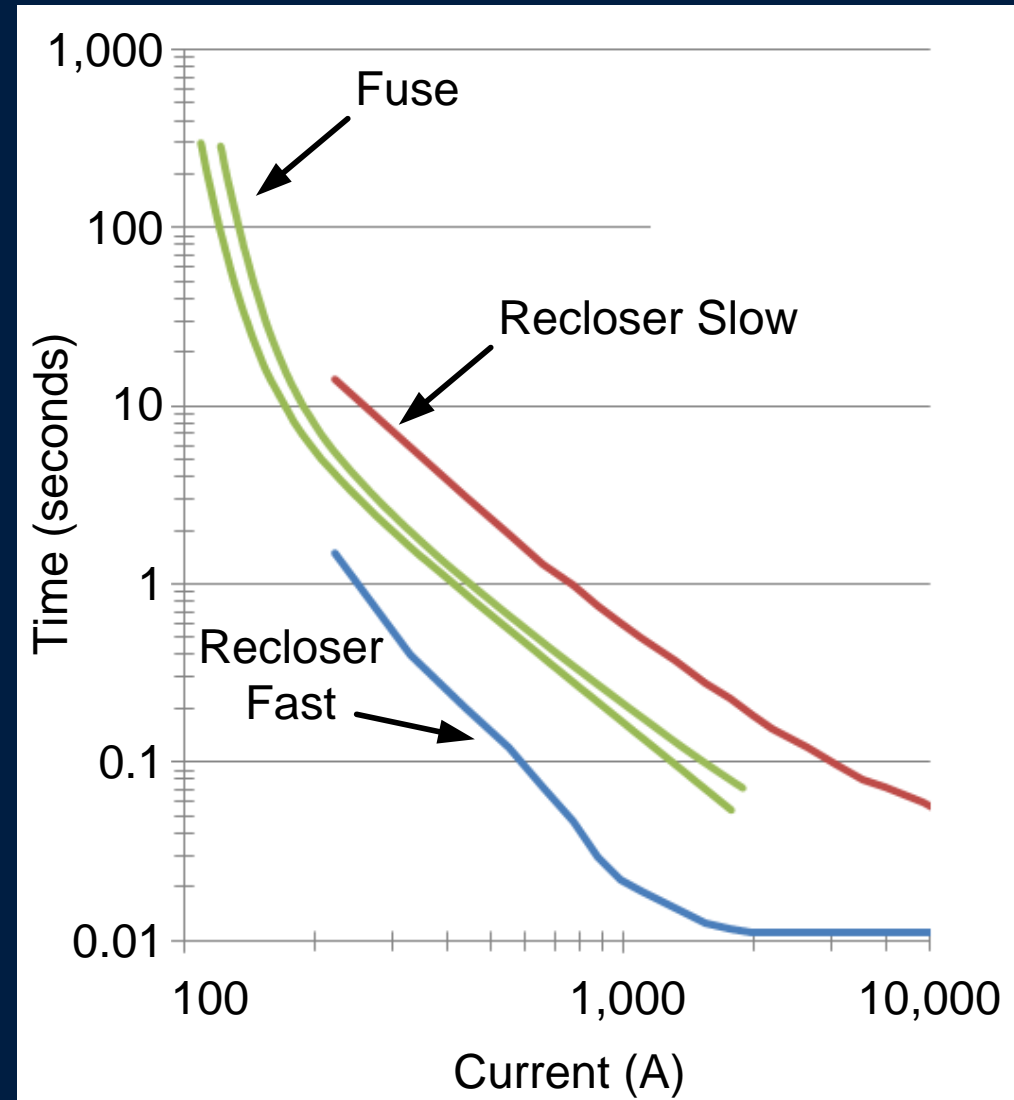
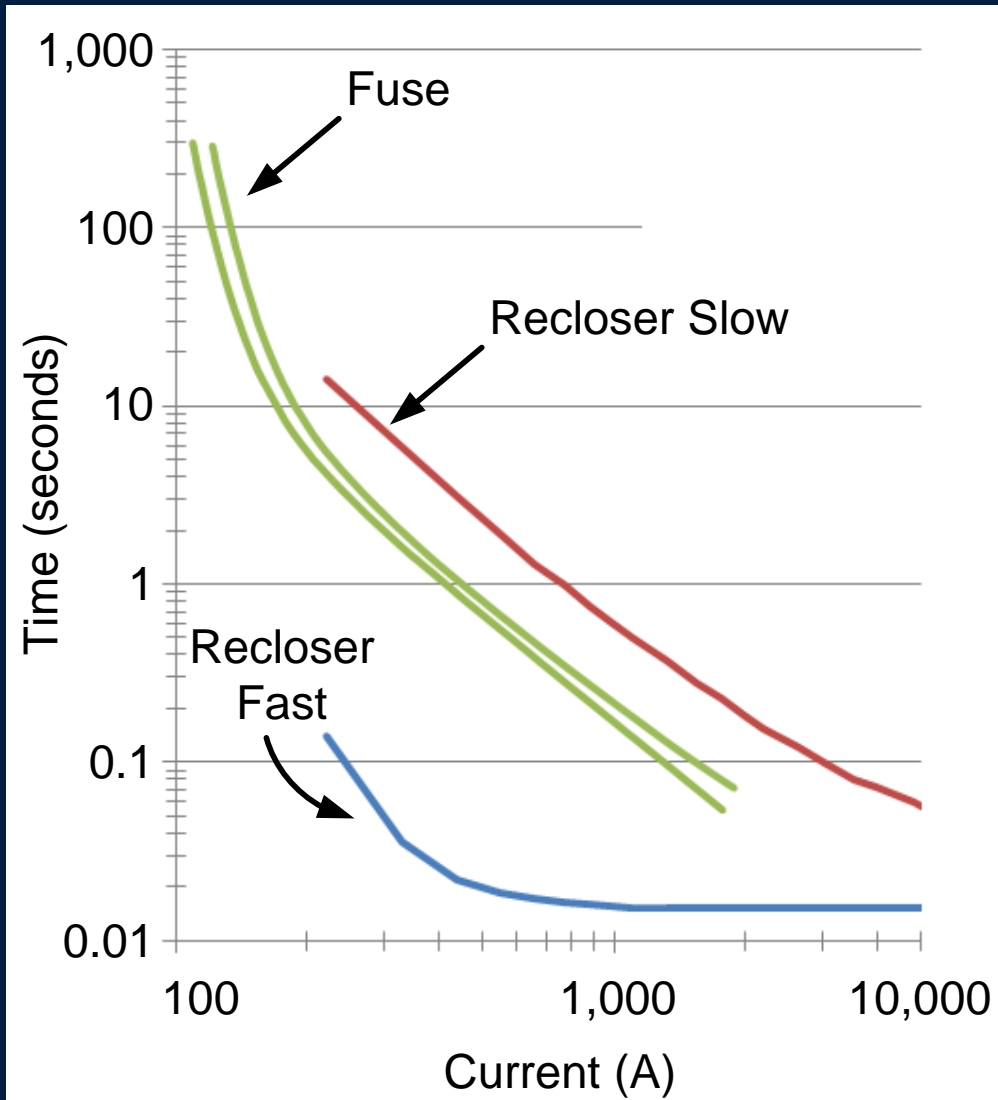

Eliminate Unnecessary Fast-Curve Operations

Solution 2 – Predict Inrush and Block Fast Curve

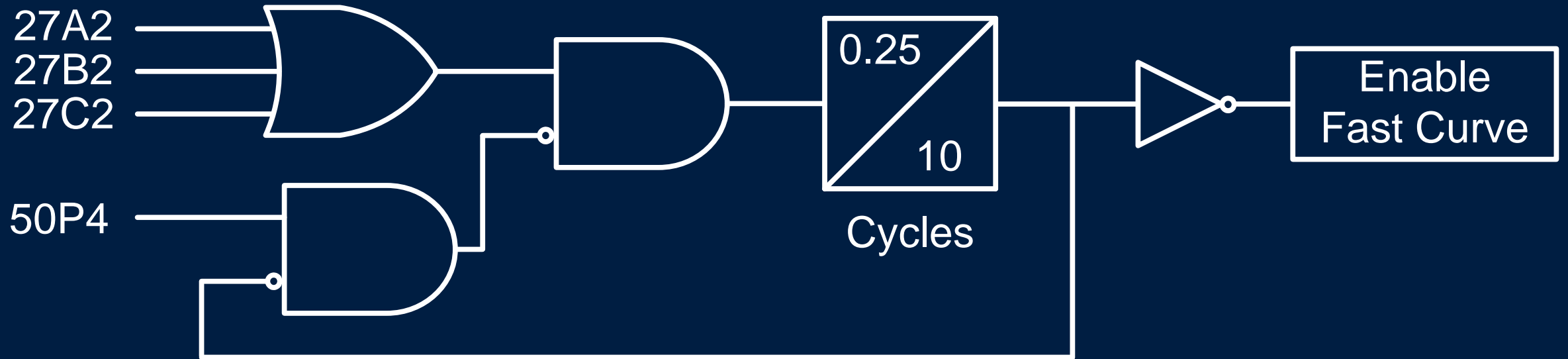

Eliminate Unnecessary Fast-Curve Operations

Solution 3 – Detect Inrush With Second Harmonic

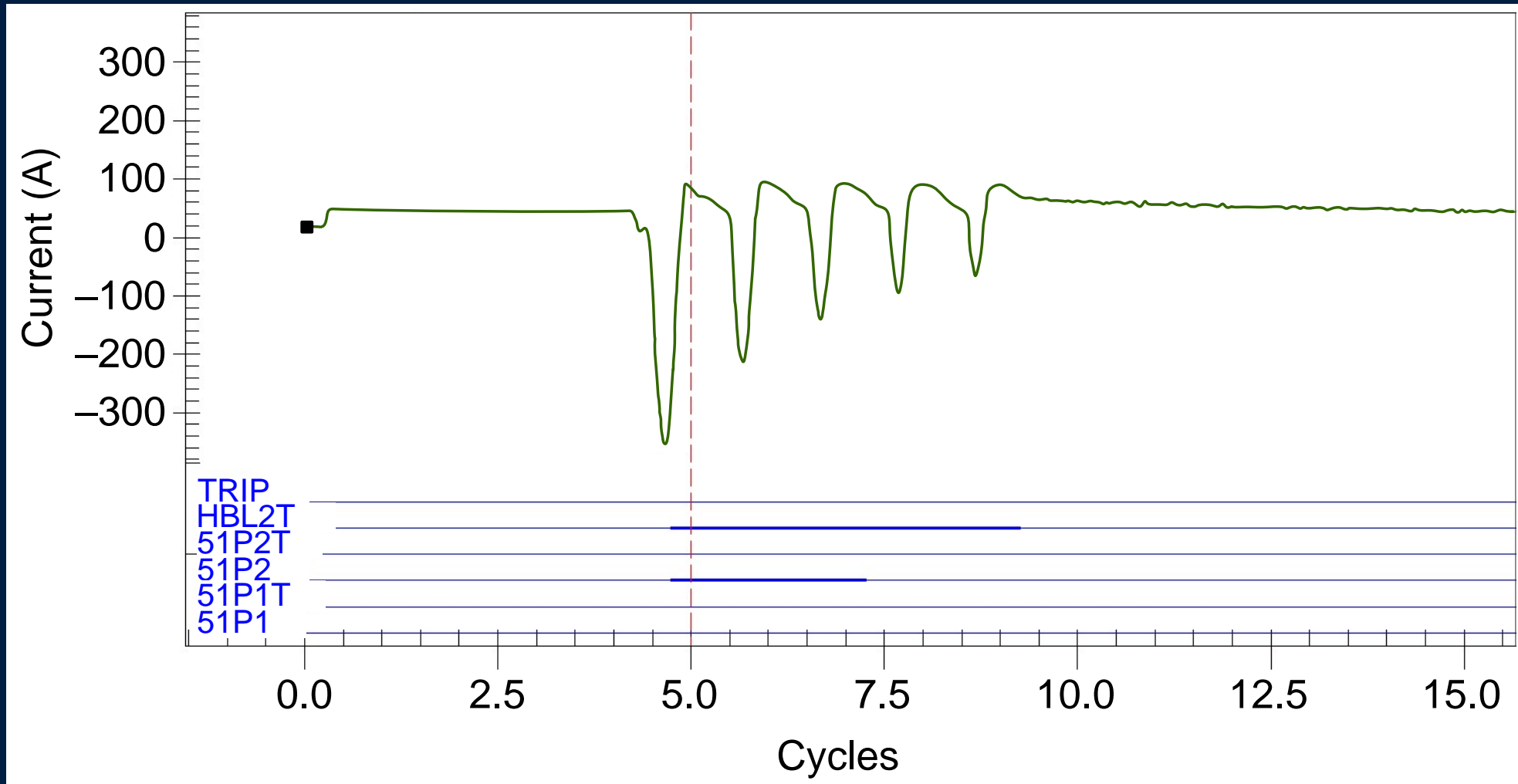

Reduce Time-Overcurrent Protection Times

Problem

- Typical coordination interval is ~ 0.2 second
- Fuse size (100T) may be limited by downstream load
- Feeder curve may be limited by upstream overcurrent protection or damage curves

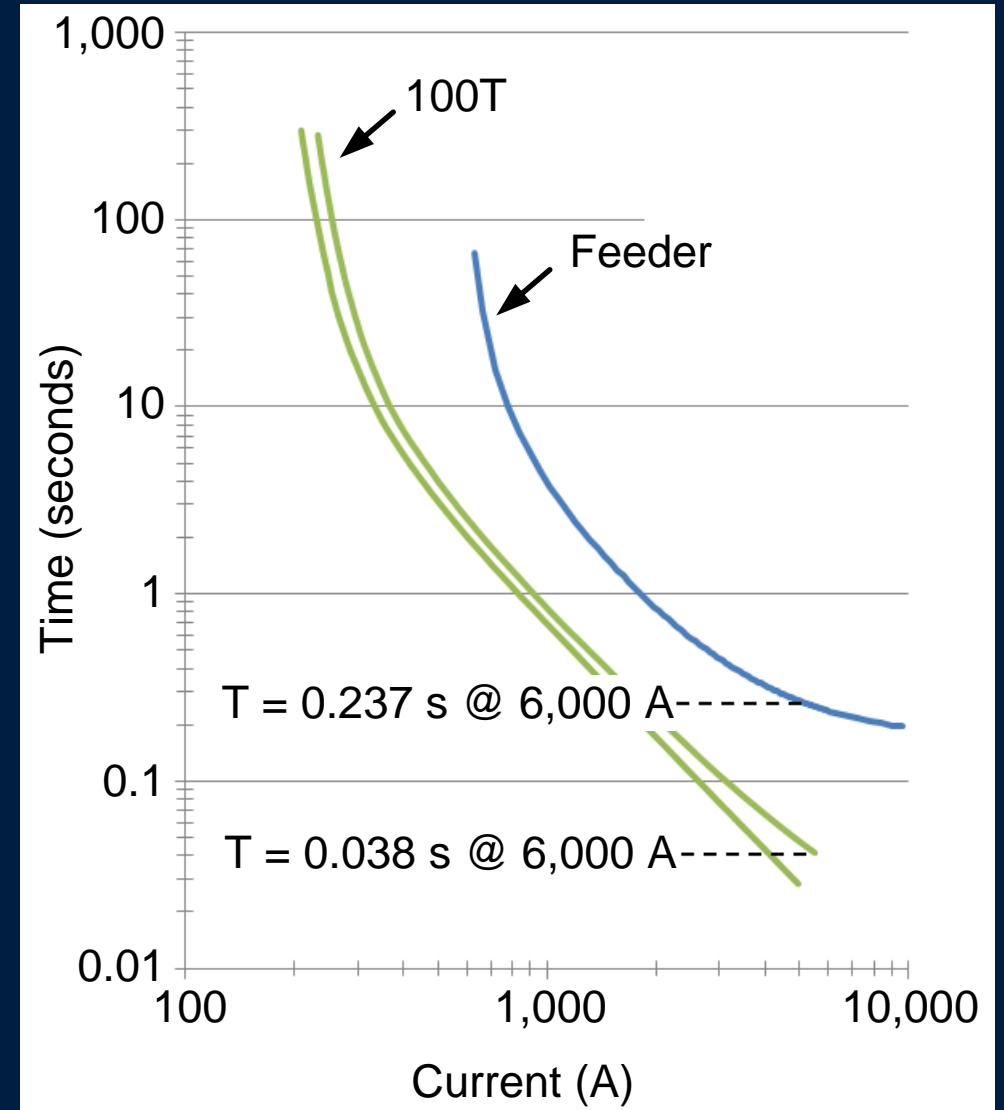

Reduce Time-Overcurrent Protection Times

Example

- Recloser installed between feeder and 100T fuse is meant to improve feeder sectionalization
- Coordination interval does not allow for it

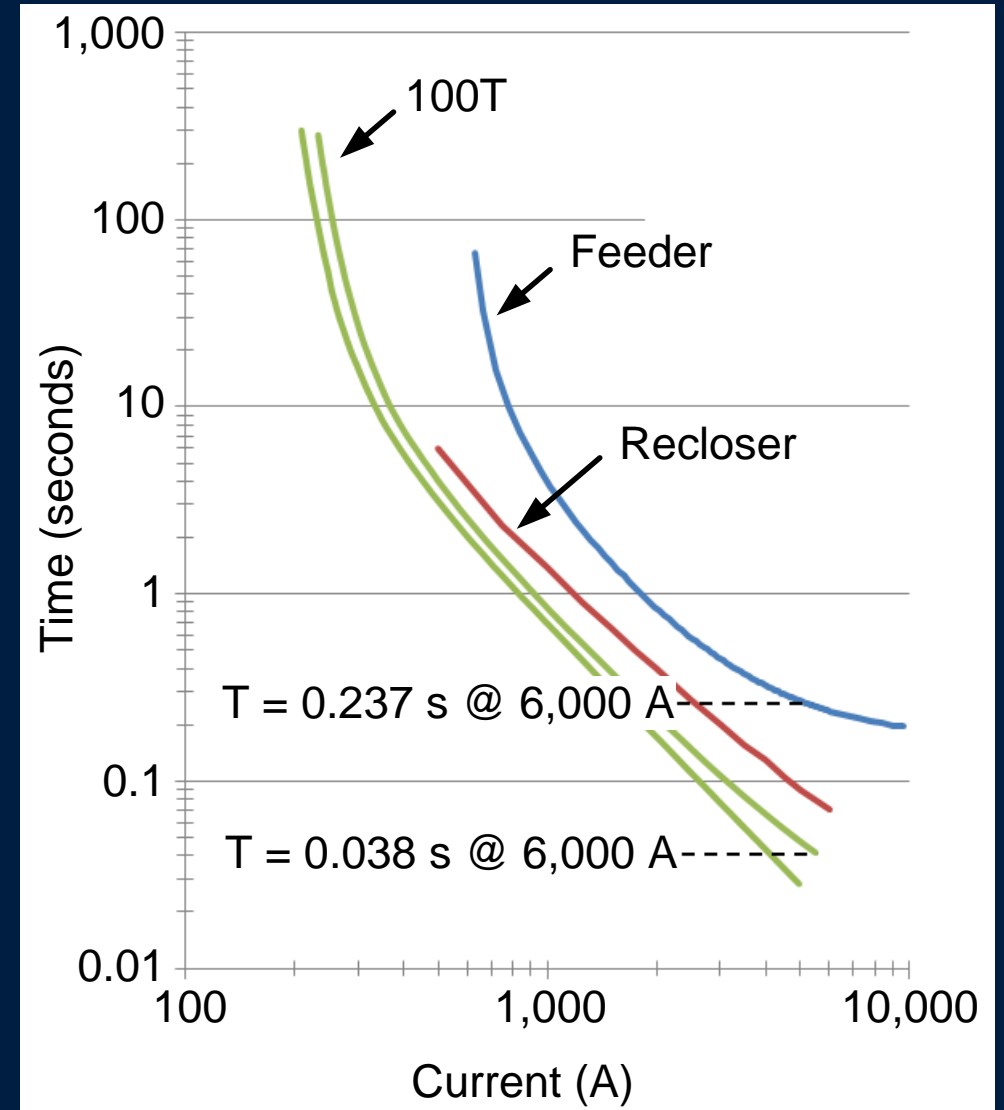

Reduce Time-Overcurrent Protection Times

Solution 1 – Faster Curve on Reclose

- Allow feeder and recloser to miscoordinate on first time-overcurrent trip

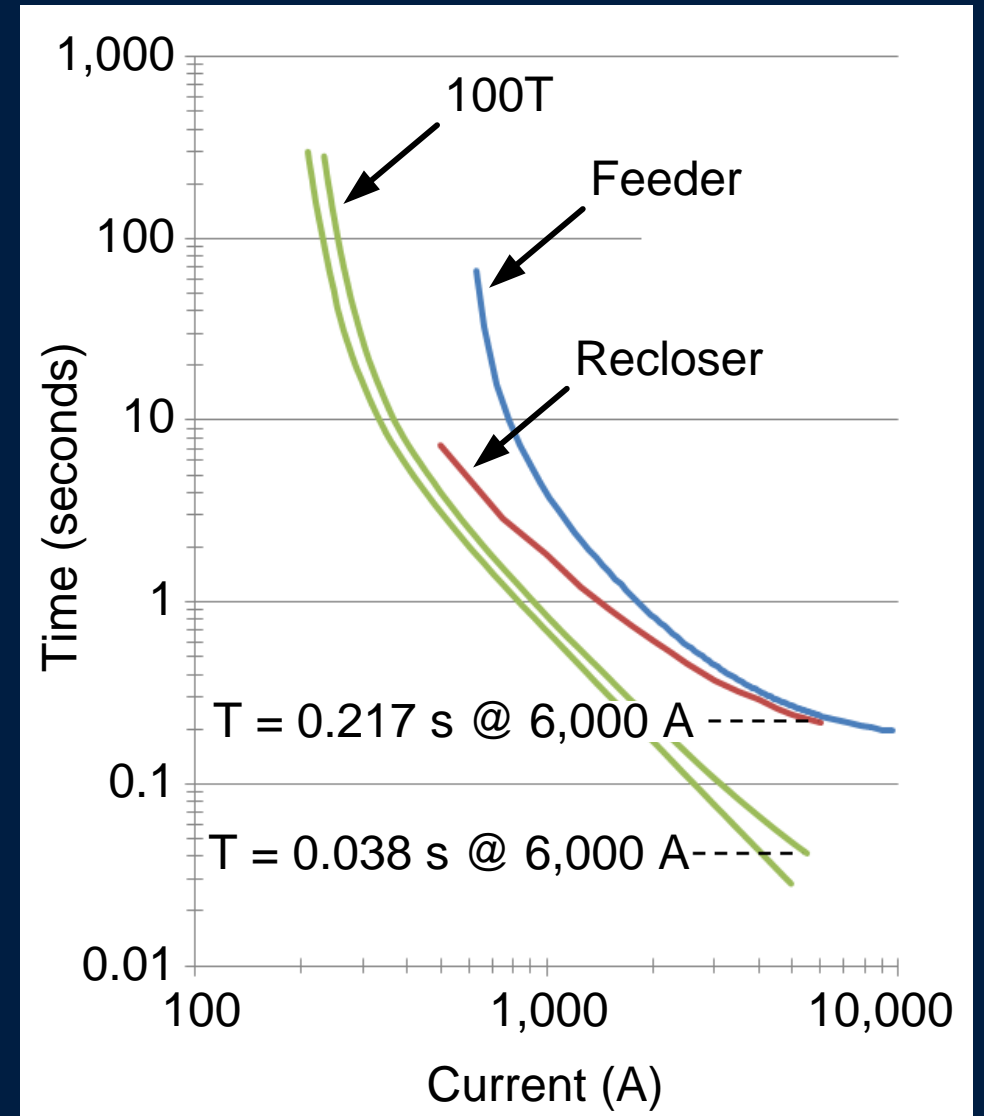

Reduce Time-Overcurrent Protection Times

Solution 1 – Faster Curve on Reclose

- Allow feeder and recloser to miscoordinate on first time-overcurrent trip
- Use faster curve on recloser for subsequent time-overcurrent trips

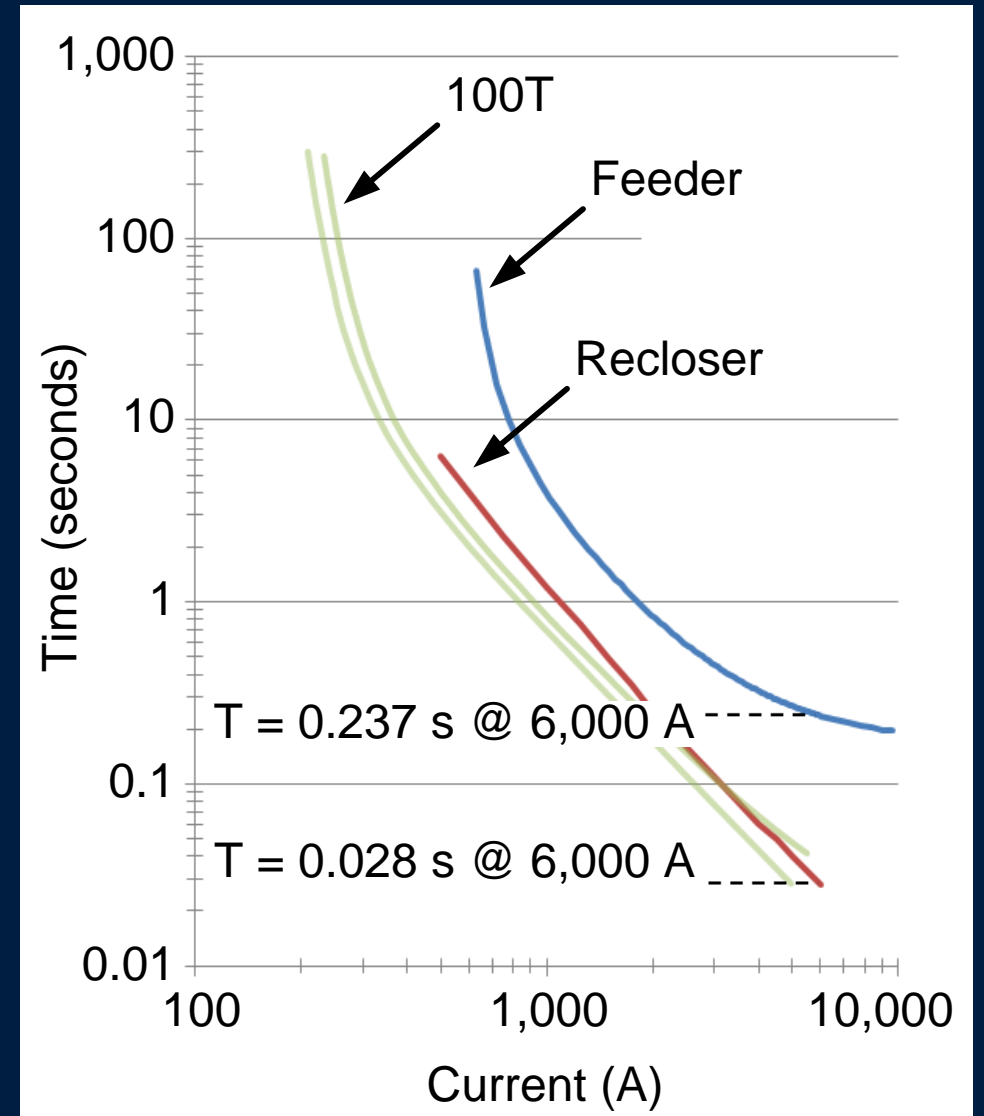

Reduce Time-Overcurrent Protection Times

Solution 2 – Even Faster Curve on Reclose

- Allow feeder and recloser to miscoordinate on first time-overcurrent trip

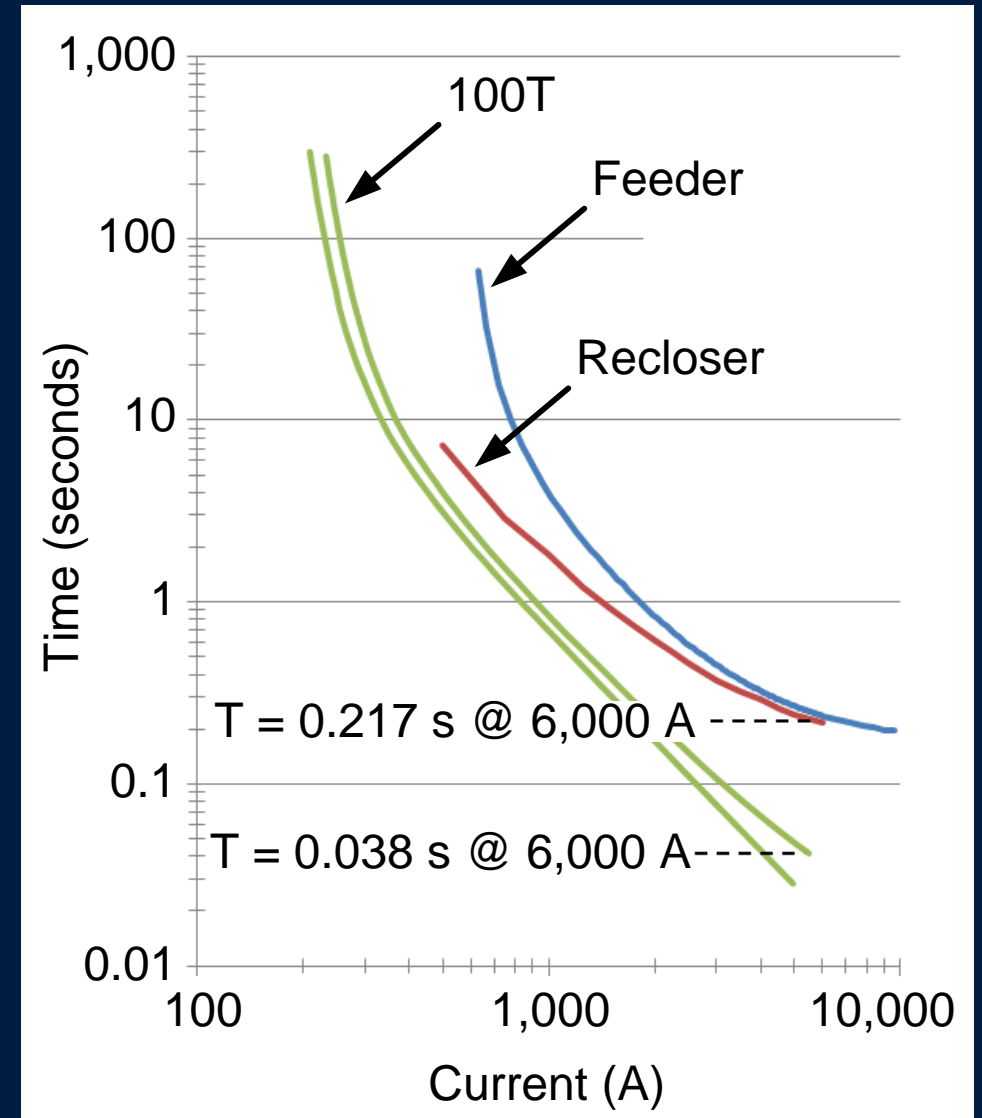

Reduce Time-Overcurrent Protection Times

Solution 2 – Even Faster Curve on Reclose

- Allow feeder and recloser to miscoordinate on first time-overcurrent trip
- Use instantaneous or short time-delay overcurrent to reduce through-fault energy

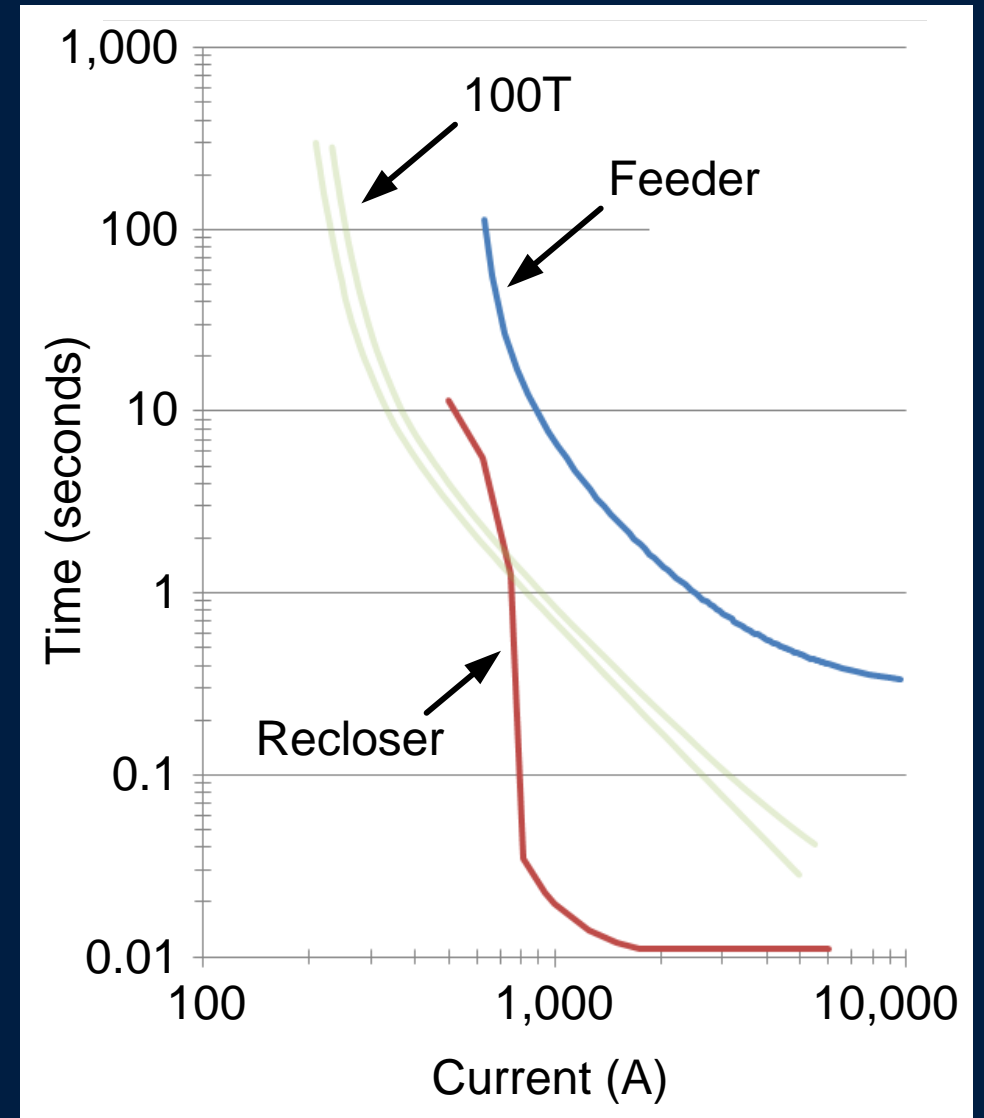

Prevent Feeder Lockout Due to Conductor Slap Problem

Fault develops
downstream of recloser



Prevent Feeder Lockout Due to Conductor Slap Problem

Fault develops
downstream of recloser



Magnetic field from fault
current causes upstream
conductors to contact

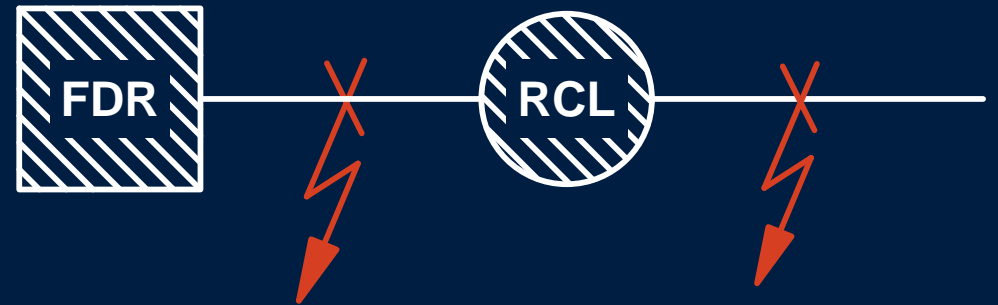

Prevent Feeder Lockout Due to Conductor Slap Problem

Fault develops downstream of recloser



Magnetic field from fault current causes upstream conductors to contact

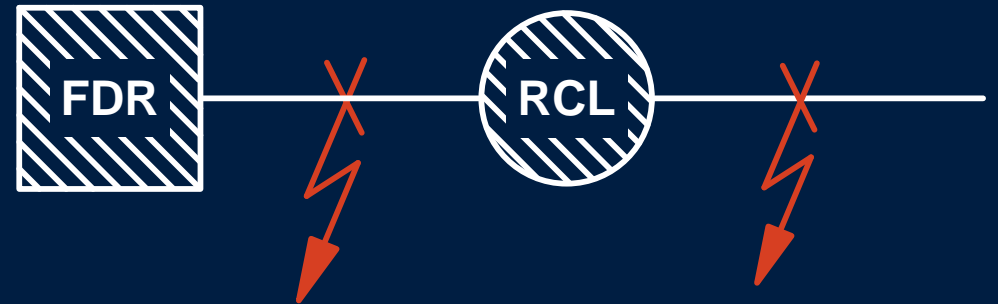

Feeder trips, but recloser may not trip



Prevent Feeder Lockout Due to Conductor Slap

Example – Multiple Conductor Slaps After Fault Clears

Recloser

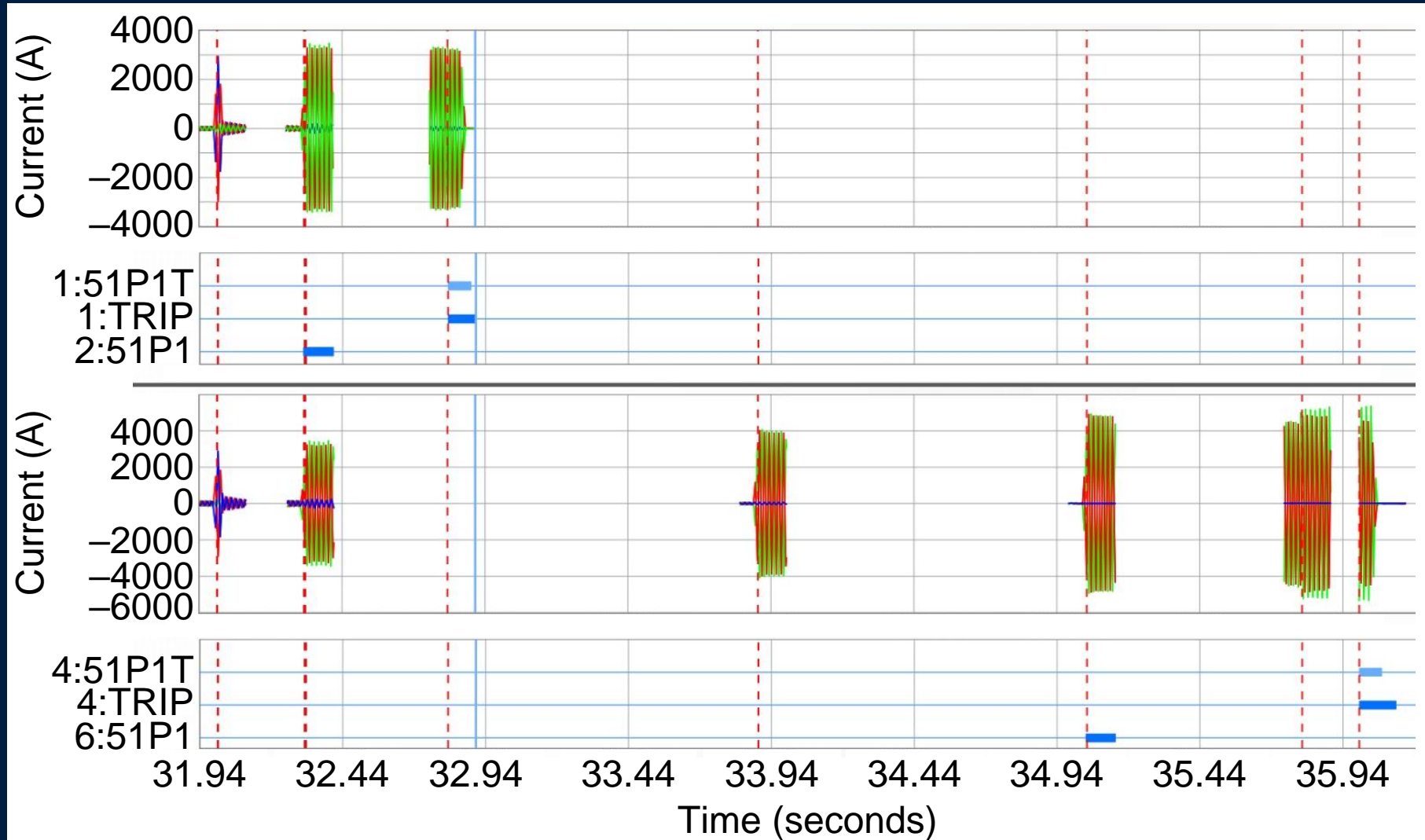

Feeder

Pitting and Beading Due to Conductor Slap

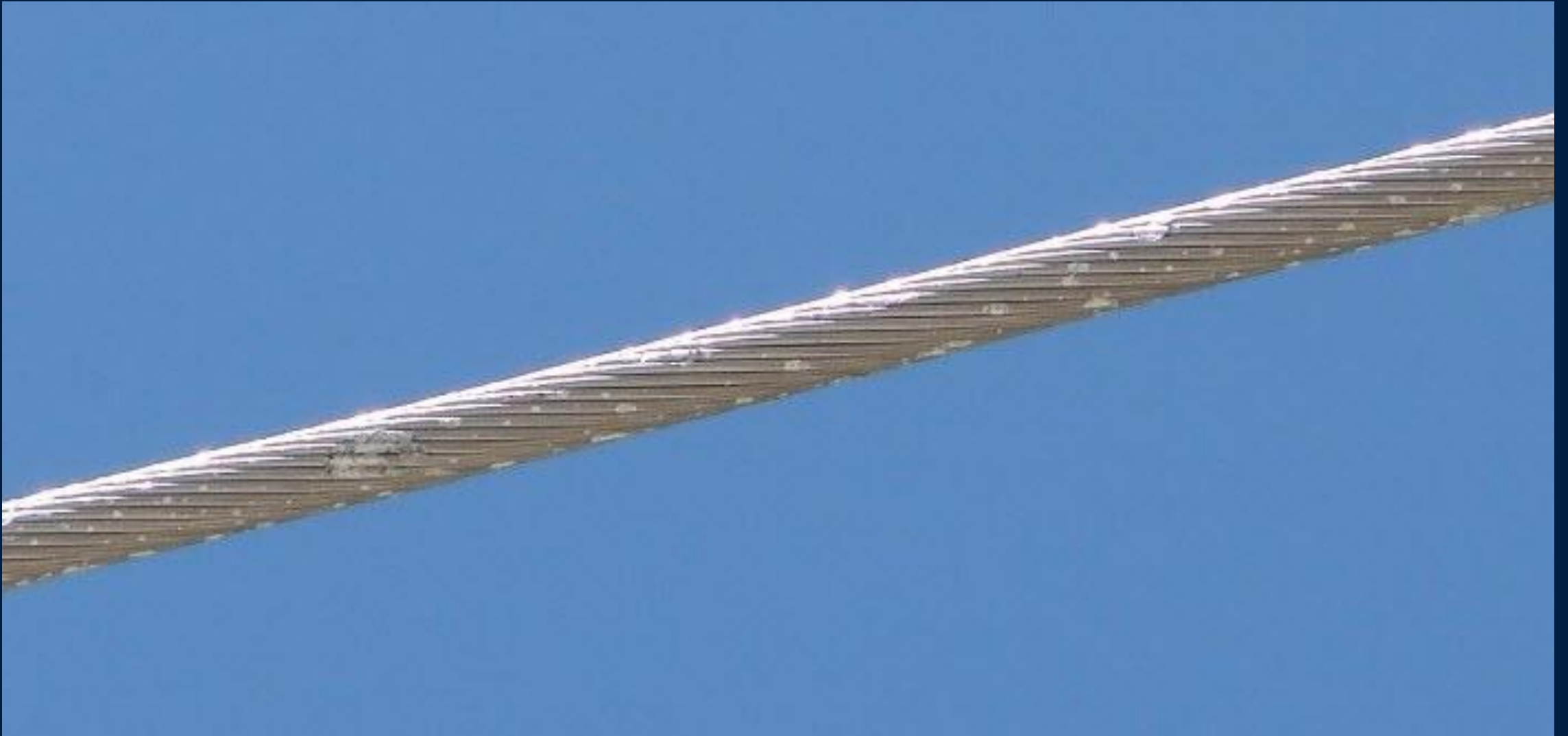

Prevent Feeder Lockout Due to Conductor Slap Solution

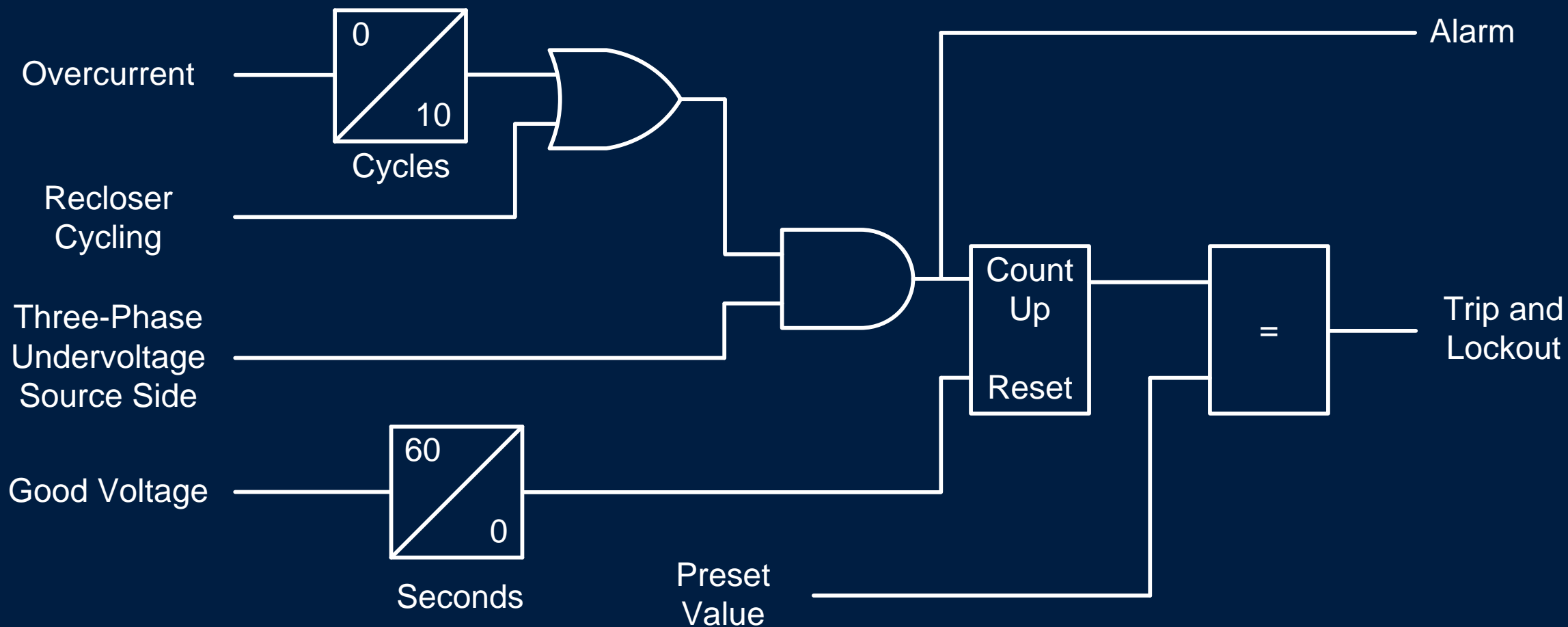

Prevent Restoration of Faulted Lines in Noncommunicating Loop Schemes

Problem

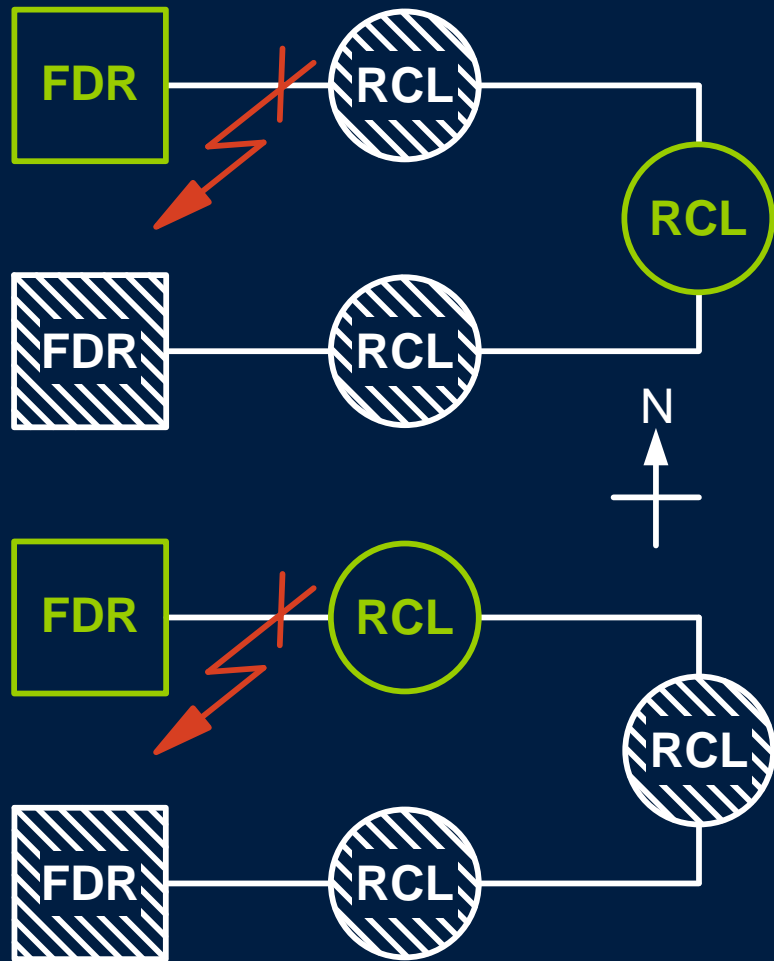

vs.

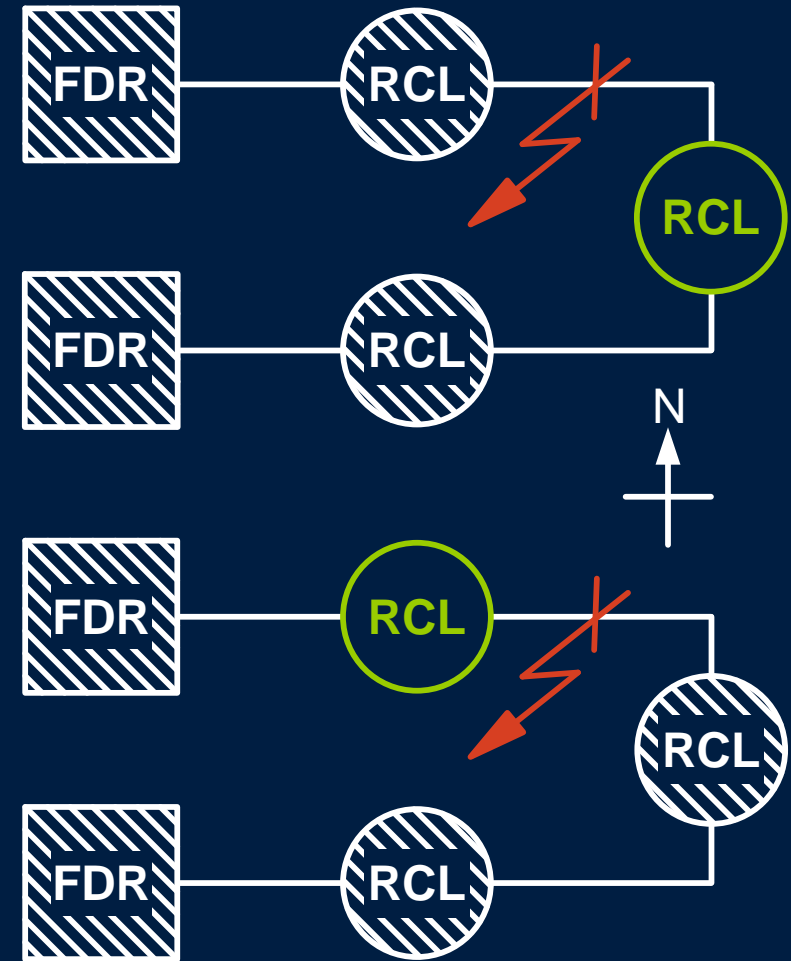

Prevent Restoration of Faulted Lines in Noncommunicating Loop Schemes

Solution

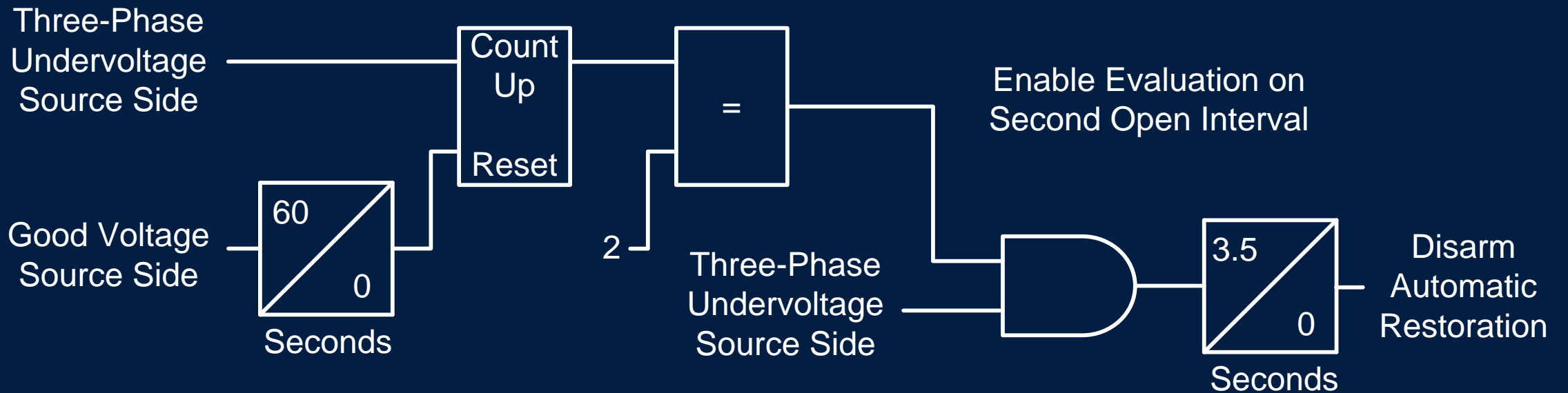

Feeder 2nd Open Interval
3 seconds

Recloser 2nd Open Interval
5 seconds

Conclusion

- Data from modern relays help explain complex distribution protection problems
- Multiple protection elements and custom logic can improve
 - **Security** of fuse-saving schemes
 - **Selectivity** of tightly coordinated feeders
 - **Speed** of overcurrent protection during reclose cycle
 - **Security** of feeders at risk of conductor slap
 - **Selectivity** of noncommunicating loop schemes

Questions?

